

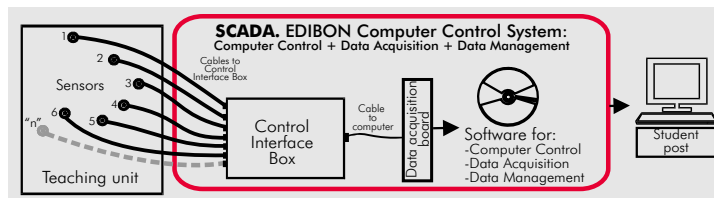

① Unit: THIBAR22C. Heat Pump + Air Conditioning + Refrigeration Unit with Cycle Inversion Valve (two condensers (water and air) and two evaporators (water and air)).

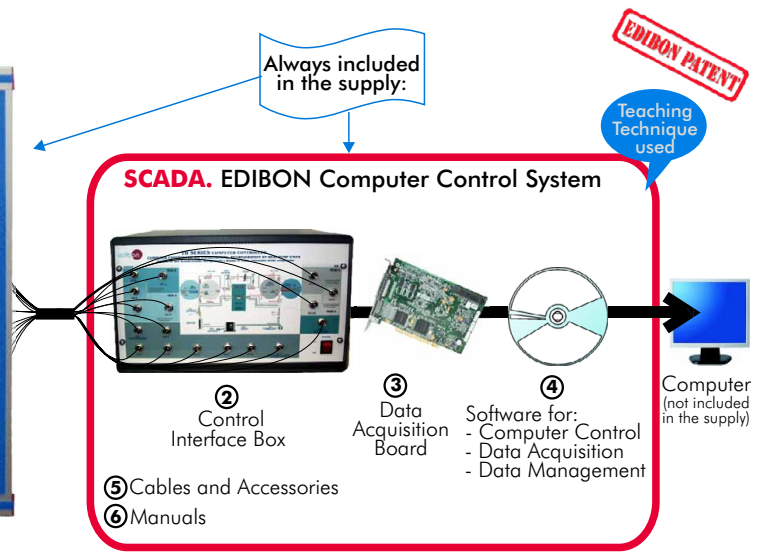

www.edibon.com

- Products
- Products range
- Units
- 9. Thermodynamics & Thermotechnics

PROCESS DIAGRAM AND ELEMENTS ALLOCATION

9 UNITS IN ONE

6 of them Heat Pump + Air Conditioning + Refrigeration and 3 of them Heat Pump + Air Conditioning.

All these units are included in the unit THIBAR22C, as it has 2 EVAPORATORS, 2 CONDENSERS and CYCLE INVERSION VALVE

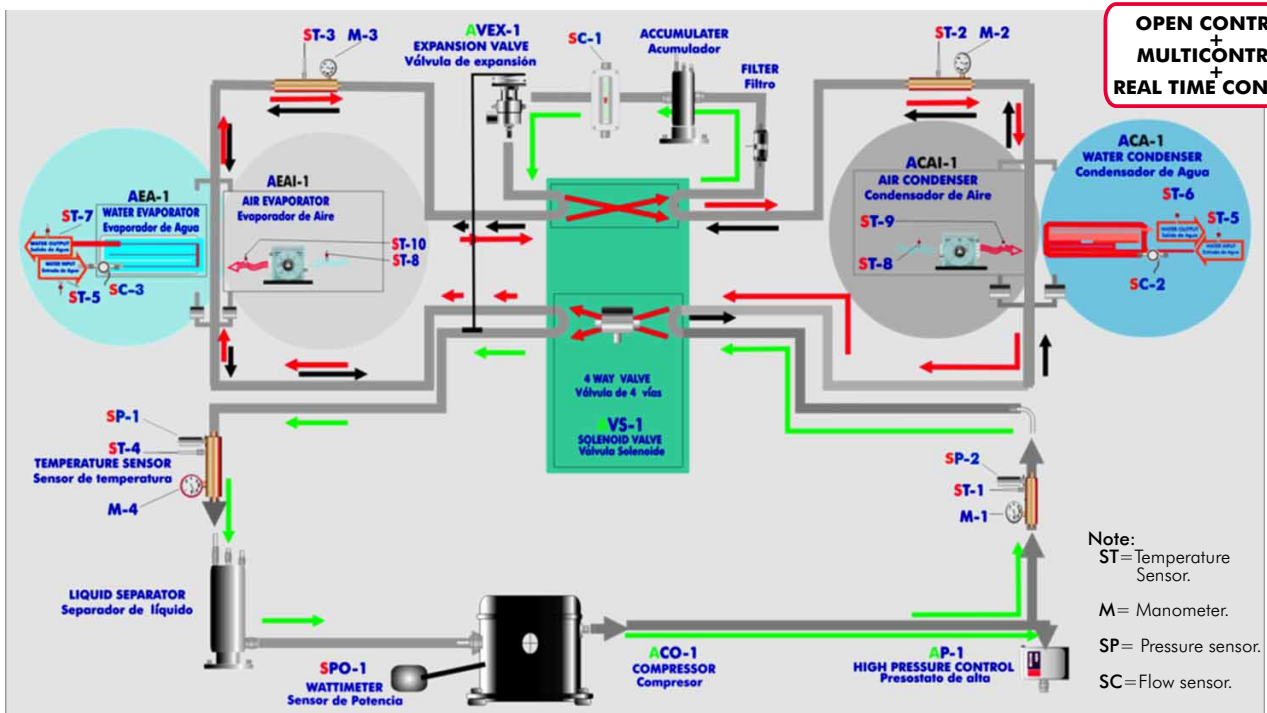

ISO 9000: Quality Management (for Design, Manufacturing, Commercialization and After-sales service)



European Union Certificate (total safety)



Certificates ISO 14000 and ECO-Management and Audit Scheme (environmental management)



Worlddidac Quality Charter Certificate (Worlddidac Member)

Items supplied as standard

① THIBAR22C. Unit:

- Bench-top unit.
- Anodized aluminium structure and panels in painted steel (epoxy paint).
- Main metallic elements in stainless steel.
- Diagram in the front panel with similar distribution to the elements in the real unit.
- Cooling compressor, computer controlled.
- Air condenser, computer controlled.
- Water condenser.
- High pressure control.
- Coolant accumulation tank.
- Cooling filter.
- Expansion valve.
- Water evaporator.
- Air evaporator, computer controlled
- Tank of division of the cooling liquid.
- 4 Manometers.
- 10 Temperature sensors (4 sensors measure the cooling temperature, 3 sensors measure the water temperature, 3 sensors measure the air temperature):
 - Temperature sensor, J type (compressor outlet).
 - Temperature sensor, J type (condenser outlet/ evaporator inlet).
 - Temperature sensor, J type (evaporator inlet/ condenser outlet).
 - Temperature sensor, J type (compressor inlet).
 - Temperature sensor, J type (water inlet).
 - Temperature sensor, J type (condenser outlet/evaporator).
 - Temperature sensor, J type (evaporator outlet/ condenser).
 - Temperature sensor, J type (room air).
 - Temperature sensor, J type (condenser outlet/ evaporator).
 - Temperature sensor, J type (evaporator outlet/ condenser).
- 3 Flow sensors:
 - Cooling flow sensor.
 - Water flow sensor (water condenser).
 - Water flow sensor (water evaporator).
- 2 Pressure sensors:
 - Cooling pressure sensor (compressor outlet).
 - Cooling pressure sensor (compressor inlet).
- Wattmeter.
- Cycle Inversion valve. 4-way valve.
- Enthalpy diagram of the refrigerant R134a.



THIBAR22C. Unit

② THIBAR22C/CIB. Control Interface Box:

- Control interface box with process diagram in the front panel and with the same distribution that the different elements located in the unit, for an easy understanding by the student.
- All sensors, with their respective signals, are properly manipulated from -10V. to +10V. Computer output. Sensors connectors in the interface have different pines numbers (from 2 to 16), to avoid connection errors. Single cable between the control interface box and computer.
- The unit control elements are permanently computer controlled, without necessity of connections during the whole process test procedure.
- Simultaneously visualization in the computer of all parameters involved in the process.
- Calibration of all sensors involved in the process.
- Real time curves representation about system responses. Storage of all the process data and results in a file. Graphic representation, in real time, of all the process/system responses.
- All the actuators' values can be changed at any time from the keyboard allowing the analysis about curves and responses of the whole process. All the actuators and sensors values and their responses are placed in only one computer screen.
- Shield and filtered signals to avoid external interferences.
- Real time computer control with flexibility of modifications from the computer keyboard of the parameters, at any moment during the process.
- Real time computer control for pumps, compressors, resistances, control valves, etc.
- Open control allowing modifications, at any time and in a real time, of parameters involved in the process simultaneously.
- Three safety levels, one mechanical in the unit, other electronic in control interface and the third one in the control software.



THIBAR22C/CIB

③ DAB. Data Acquisition Board:

- PCI Data acquisition board (National Instruments) to be placed in a computer slot. Bus PCI.
- Analog input: Number of channels= 16 single-ended or 8 differential. Resolution= 16 bits, 1 in 65536. Sampling rate up to: 250 KS/s (Kilo samples per second). Input range (V)=±10V. Data transfers=DMA, interrupts, programmed I/O. Number of DMA channels=6.
- Analog output: Number of channels=2. Resolution= 16 bits, 1 in 65536. Maximum output rate up to: 833 KS/s. Output range(V)=±10V. Data transfers=DMA, interrupts, programmed I/O.
- Digital Input/Output: Number of channels=24 inputs/outputs. DO or DI Sample Clock frequency: 0 to 1 Mhz.



DAB

④ THIBAR22C/CCSOF. Computer Control + Data Acquisition + Data Management Software:

- Compatible with actual Windows operating systems. Graphic and intuitive simulation of the process in screen.
- Compatible with the industry standards.
- Registration and visualization of all process variables in an automatic and simultaneously way.
- Flexible, open and multicontrol software, developed with actual windows graphic systems, acting simultaneously on all process parameters.
- Management, processing, comparison and storage of data.
- Sampling velocity up to 250,000 data per second guaranteed.
- Calibration system for the sensors involved in the process.
- It allows the registration of the alarms state and the graphic representation in real time.
- Comparative analysis of the obtained data, after the process and modification of the conditions during the process.
- Open software, allowing to the teacher to modify texts, instructions. Teacher's as student's passwords to facilitate the teacher's control on the student, and allowing the access at different work levels.
- This unit allows that the 30 students of the classroom can visualize simultaneously all results and manipulation of the unit, during the process, by using a projector.

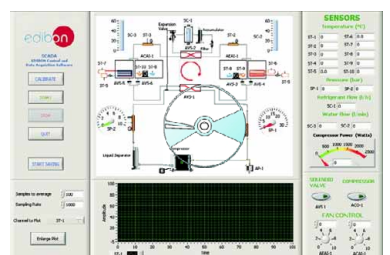

THIBAR22C/CCSOF

⑤ Cables and Accessories, for normal operation.

⑥ Manuals: This unit is supplied with 8 manuals: Required Services, Assembly and Installation, Interface and Control Software, Starting-up, Safety, Maintenance, Calibration & Practices Manuals.

*** References 1 to 6: THIBAR22C + THIBAR22C/CIB + DAB + THIBAR22C/CCSOF + Cables and Accessories + Manuals are included in the minimum supply, enabling a normal operation.**

Complementary items to the standard supply

PLC. Industrial Control using PLC (7 and 8):

⑦ PLC-PI. PLC Module:

Circuit diagram in the front panel.

Front panel:

Digital inputs(X) and Digital outputs (Y) block:

16 Digital inputs, activated by switches and 16 LEDs for confirmation (red).

14 Digital outputs (through SCSI connector) with 14 LEDs for message (green).

Analog inputs block:

16 Analog inputs (-10V. to + 10V.) (through SCSI connector).

Analog outputs block:

4 Analog outputs (-10V. to + 10V.) (through SCSI connector).

Touch screen:

High visibility and multiple functions.

Display of a highly visible status.

Recipe function.

Bar graph function.

Flow display function.

Alarm list.

Multi language function.

True type fonts.

Back panel:

Power supply connector.

Fuse 2A.

RS-232 connector to PC.

USB 2.0 connector to PC.

Inside:

Power supply outputs: 24 Vdc, 12 Vdc, - 12 Vdc, 12 Vdc variable.

Panasonic PLC:

High-speed scan of 0.32 μsec. for a basic instruction.

Program capacity of 32 Ksteps, with a sufficient comment area.

Free input AC voltage(100 to 240 V AC).

DC input: 16 (24 VDC).

Relay output: 14 (250 VA AC/2 A).

High-speed counter.

Multi-point PID control.

Digital inputs/outputs and analog inputs/outputs Panasonic modules.

Communication RS232 wire, to computer (PC).

⑧ THIBAR22C/PLC-SOF. PLC Control Software:

For this particular unit, always included with PLC supply.



PCL-PI

Items available on request

⑨ THIBAR22C/CAL. Computer Aided Learning Software (Results Calculation and Analysis).

⑩ THIBAR22C/FSS. Faults Simulation System.

Software Main Screens

Main screen

The main screen displays a refrigeration cycle diagram with components like the Compressor, Liquid Separator, Expansion Valve, Accumulator, Filter, and various sensors (ST-1 to ST-10, SP-1, SP-2, SC-1, SC-2, SC-3, AVS-1 to AVS-6, AEA1-1, ACAI-1, AP-1). On the left, there are control buttons: CALIBRATE, START, STOP, QUIT, and START SAVING. Below these are settings for 'Samples to average' (100), 'Sampling Rate' (1000), and 'Channel to Plot' (ST-1). A plot shows Amplitude vs Time for channel ST-1. On the right, there are readouts for SENSORS (Temperature, Pressure, Refrigerant Flow, Water Flow, Compressor Power), SOLENOID VALVE (AVS 1), COMPRESSOR (ACO-1), and FAN CONTROL (AEA1-1, ACAI-1).

Note: ST= Temperature sensor. SP= Pressure sensor. SC= Flow sensor. AVS-1= Solenoid valve. ACO-1= Compressor. AEA1-1= Air evaporador. ACAI-1= Air condenser.

Examples of Sensors Calibration screens

The CALIBRATION window shows settings for an Analog Input Channel (ST-8) with Sensor Name ST-8, Calibration units °C, Full Scale 150, Gain 95,4198, and Offset 1,67443. It includes a Least Squares Fit button and a PTA setting of 10. The MULTICALIBRATE window shows a table of sensor calibration data:

| Sensors | Volts | Calibrated | Err (%) |
|---------|---------|------------|---------|
| ST-1 | 0,2046 | 22,3821 | 0,82 |
| ST-2 | 0,2292 | 23,483 | 0,28 |
| ST-3 | 0,2353 | 23,1522 | 0,05 |
| ST-4 | 0,2301 | 23,2113 | 0,01 |
| ST-5 | 0,1527 | 13,1629 | 10,04 |
| SCC-1 | -5,2792 | 172,5154 | 149,31 |
| SC-1 | -0,1774 | 0,0319629 | 23,17 |
| | -0,2681 | -60,4623 | 83,67 |
| | -0,2251 | 0,4208 | 22,78 |
| | -0,2529 | -0,2529 | 23,46 |
| | -0,2063 | -0,1178 | 23,32 |
| | -0,2581 | -226,9384 | 250,14 |
| | -0,3634 | -0,3634 | 23,57 |
| | -0,275 | -0,275 | 23,48 |
| | -0,2005 | -0,2005 | 23,41 |

The MULTICALIBRATE window also shows a Reference Value of 23,2113 and a table for GAIN, OFFSET, and p for various sensors.

Continue...

Some typical exercises results

Main screen in which the refrigeration system temperatures are represented.

The refrigerant at the compressor outlet has high pressure (SP-1) 7.5 bar and high temperature (ST-1) 42.7 °C.

The refrigerant at the condenser outlet has high pressure and temperature (ST-3) of 30°C. In this step, the refrigerant temperature decreases, in this way the refrigerant vapour becomes a liquid.

The refrigerant at the expansion valve outlet has low pressure and low temperature (ST-2) 0.2 °C. A sharp drop of the pressure is generated, making an expansion and a sharp drop of the temperature.

The refrigerant at the evaporator outlet has low pressure (SP-2) 1.8 bar and low temperature (ST-4) 16.4 °C. In this step the expansion produces the change from liquid to vapour. It has a higher temperature than at the evaporator inlet because part of the energy to evaporate the liquid is used to cool either air or water.

The sensors ST-2 and ST-3 interchange their positions depending if the inversion valve is actuated or not.

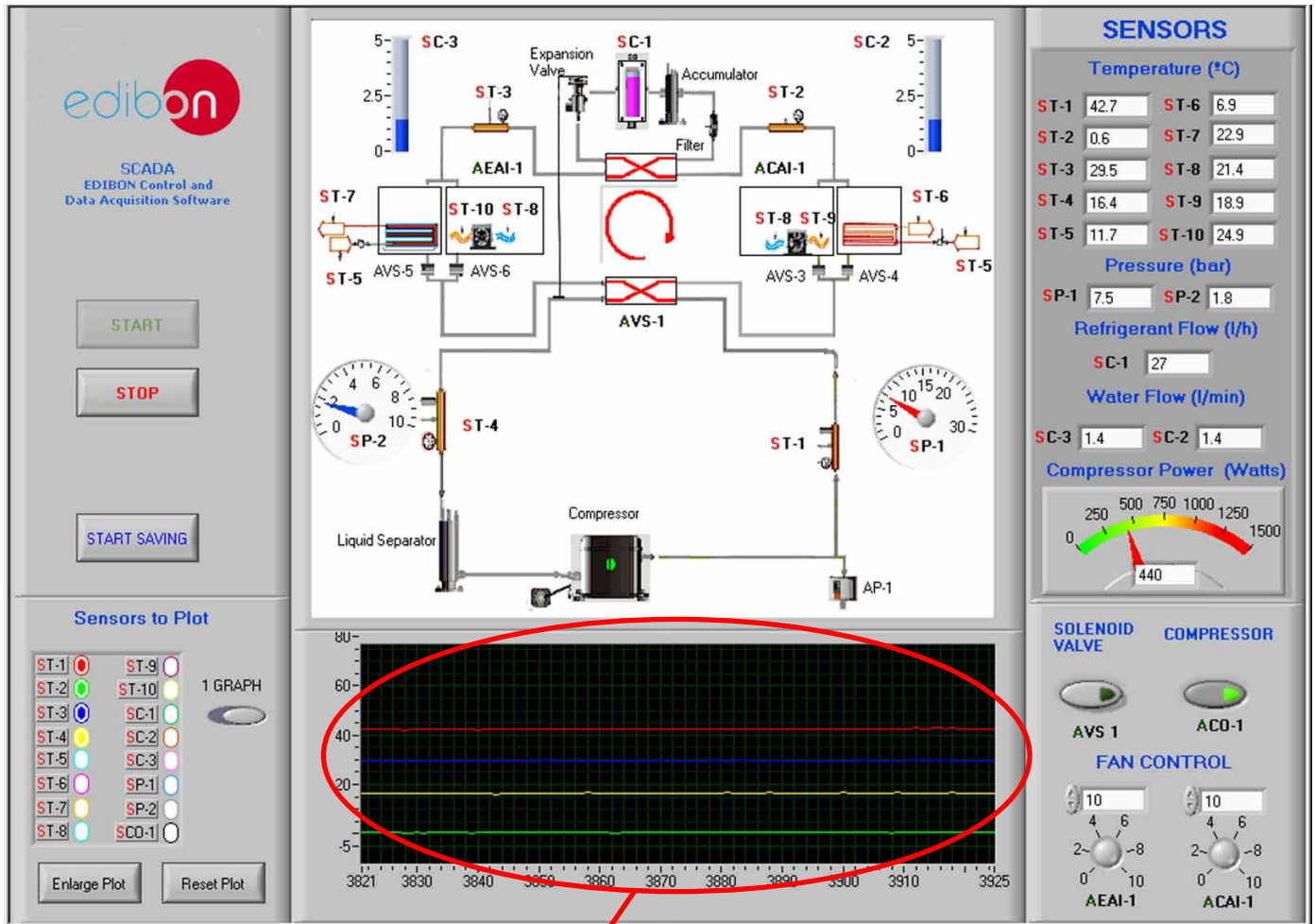

Enlargement of the graphic

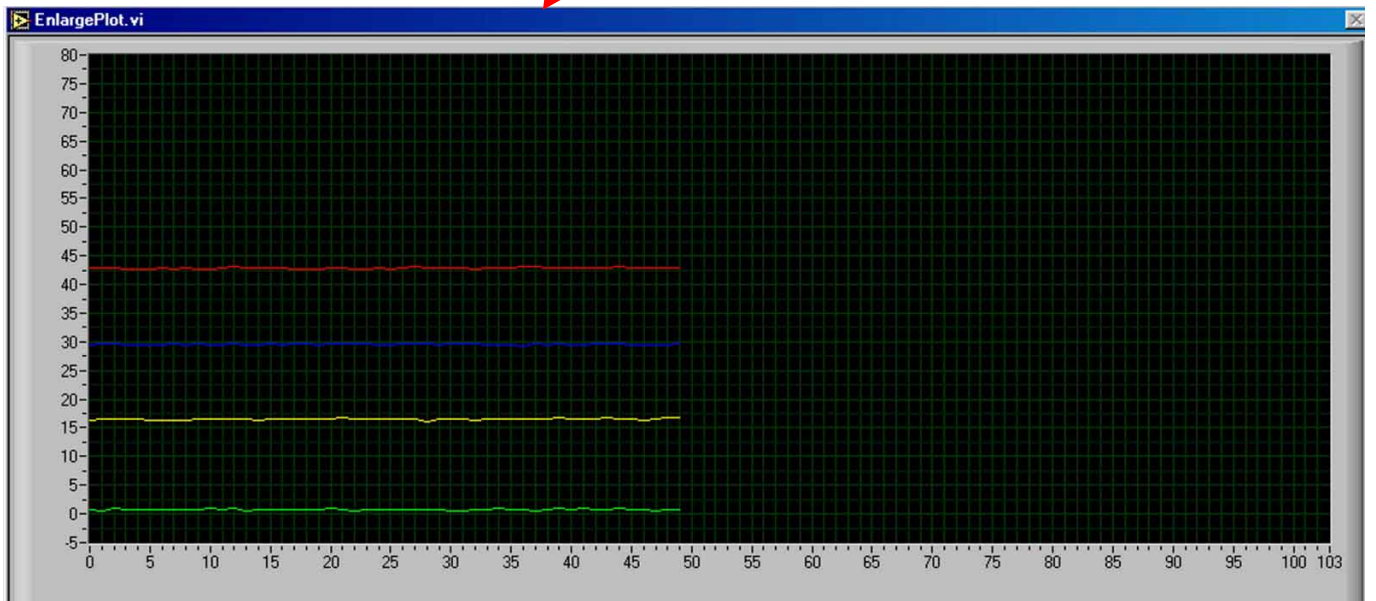

Some typical exercises results

Main screen with the water inlet and outlet temperatures of the condenser and the evaporator.
 ST-5 Water inlet 12°C.
 ST-6 Water temperature at the evaporator outlet 6°C.
 ST-7 Water temperature at the condenser outlet 22°C.

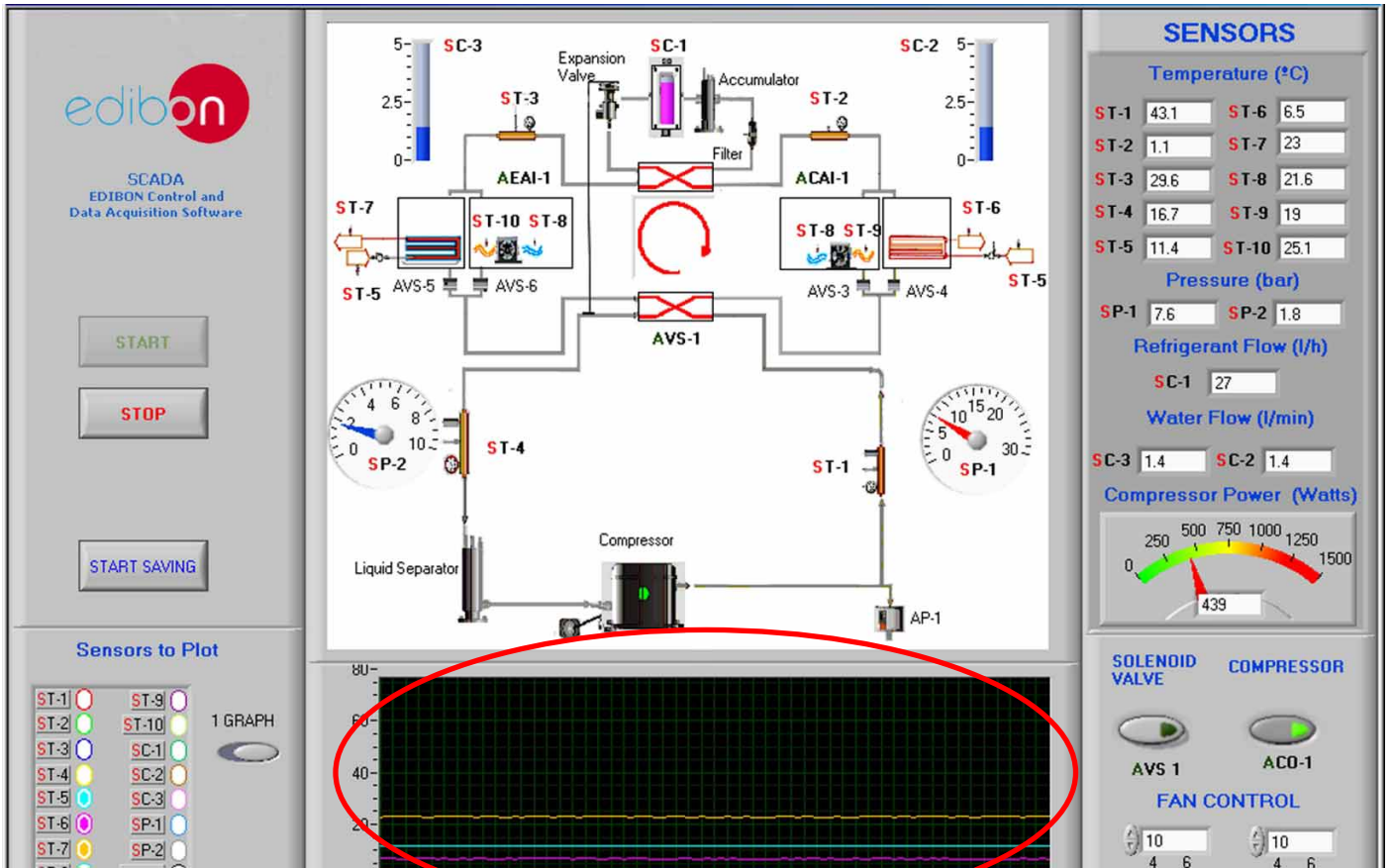

Enlargement of the graphic

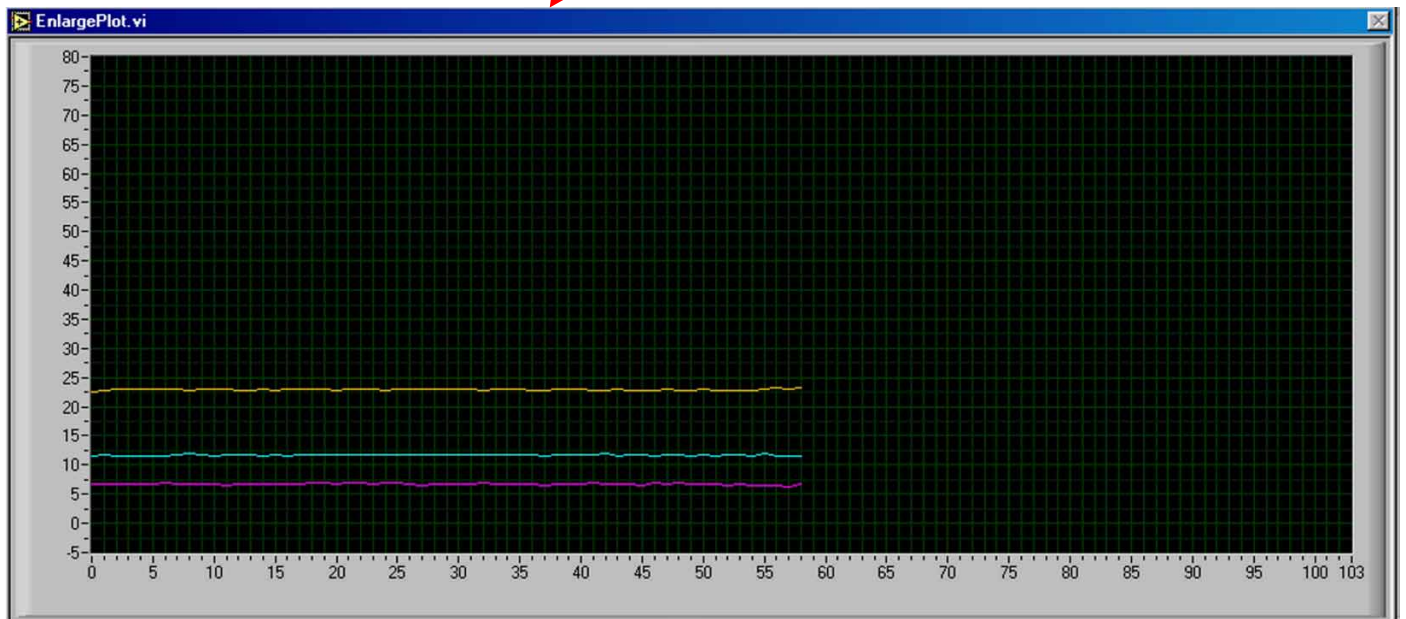

Continue...

Some typical exercises results

Main screen with the air inlet and outlet temperatures of the condenser and the evaporator.

ST-8 Air inlet 21°C.

ST-9 Air outlet from the evaporator 19°C.

ST-10 Air outlet from the condenser 25°C.

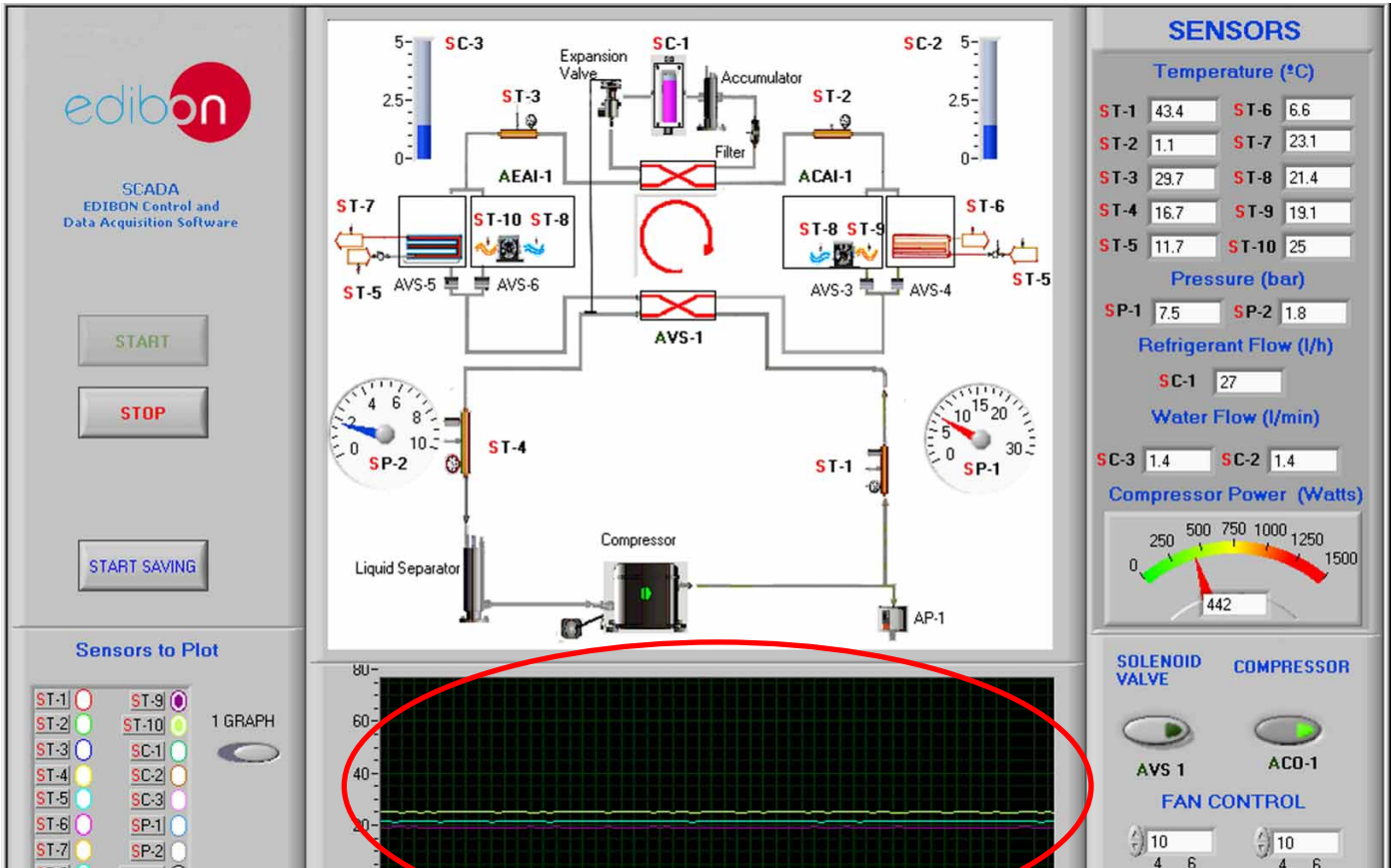

Enlargement of the graphic

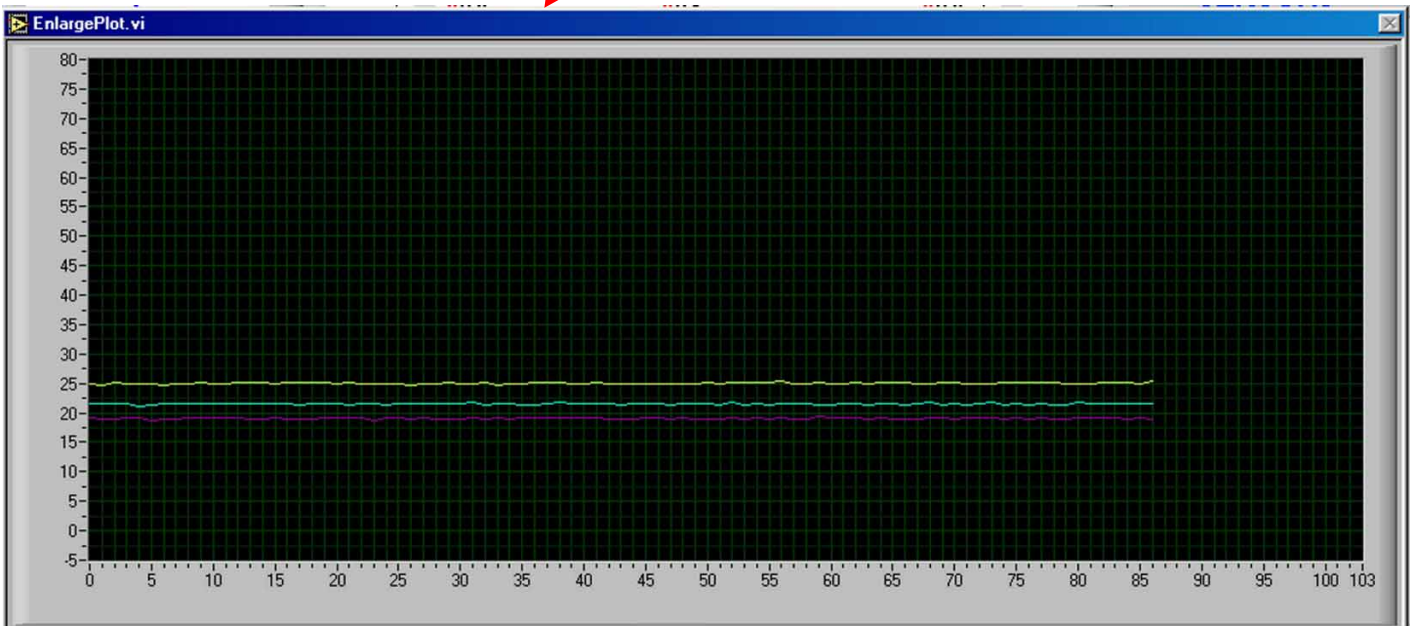

EXERCISES AND PRACTICAL POSSIBILITIES

Some Practical Possibilities of the Unit:

- 1.- Determination of the inlet power, heat produced and performance coefficient. Water as heat source. (Water-water heat pump).
 - 2.- Determination of the inlet power, produced heat and performance coefficient. Air as heat source. (Water-air heat pump).
 - 3.- Determination of the inlet power, produced heat and performance coefficient. Air as heat source. (Air-air heat pump).
 - 4.- Determination of the inlet power, heat produced and performance coefficient. Water as heat source. (Air- water heat pump).
 - 5.- Preparation of performance curves of the heat pump with different inlet and outlet temperatures. Water as heat source. (Water-water heat pump).
 - 6.- Preparation of performance curves of the heat pump at different inlet and outlet temperatures. Air as a heat source. (Water-air heat pump).
 - 7.- Preparation of performance curves of the heat pump with different inlet and outlet temperatures. Water as heat source. (Air-water heat pump).
 - 8.- Preparation of the performance curves of the heat pump with different inlet and outlet temperatures. Air as heat source. (Air-air heat pump).
 - 9.- Lay out of the steam compression cycle in a diagram P-H and comparison with the ideal cycle. Water as heat source. (Water-water heat pump).
 - 10.-Lay out of the steam compression cycle in a diagram P-H and comparison with the ideal cycle. Air as heat source. (Water-air heat pump).
 - 11.-Lay out of the steam compression cycle in a diagram P-H and comparison with the ideal cycle. Water as heat source. (Air-water heat pump).
 - 12.-Lay out of the steam compression cycle in a diagram P-H and comparison with the ideal cycle. Air as heat source. (Air-air heat pump).
 - 13.-Preparation of the performance curves of the heat pump based on the properties of the refrigerant and at different condensation and evaporation temperatures. Water as heat source. (Water-water heat pump).
 - 14.-Preparation of the performance curves of the heat pump based on the properties of the refrigerant and at different condensation and evaporation temperatures. Air as heat source. (Water-air heat pump).
 - 15.-Preparation of the performance curves of the heat pump based on the properties of the refrigerant and at different condensation and evaporation temperatures. Water as heat source. (Air-water heat pump).
 - 16.-Preparation of the performance curves of the heat pump based on the properties of the refrigerant and at different condensation and evaporation temperatures. Air as heat source. (Air- air heat pump).
 - 17.- Practices with cycle inversion.
- Other possible practices:
- 18.- Temperature sensors calibration.
 - 19.- Flow sensors calibration.
 - 20.- Refrigerant flow sensor.
 - 21.- Pressure sensors calibration.
- Practices to be done by PLC Module (PLC-PI)+PLC Control Software:
- 22.- Control of the THIBAR22C unit process through the control interface box without computer.
 - 23.- Visualization of all the sensors values used in THIBAR22C unit process.
 - 24.- Calibration of all sensors included in THIBAR22C unit process.
 - 25.- Hand on of all the actuators involved in the THIBAR22C unit process.
 - 26.- Realization of different experiments, in automatic way, without having in front the unit. (This experiment can be decided previously).
 - 27.- Simulation of outside actions, in the cases do not exist hardware elements (Example: test of complementary tanks, complementary industrial environment to the process to be studied, etc).
 - 28.- PLC hardware general use and manipulation.
 - 29.- PLC process application for the THIBAR22C unit.
 - 30.- PLC structure.
 - 31.- PLC inputs and outputs configuration.
 - 32.- PLC configuration possibilities.
 - 33.- PLC program languages.
 - 34.- PLC different programming standard languages.
 - 35.- New configuration and development of new process.
 - 36.- Hand on an established process.
 - 37.- To visualize and see the results and to make comparisons with the THIBAR22C unit process.
 - 38.- Possibility of creating new processes in relation with the THIBAR22C unit.
 - 39.- PLC Programming Exercises.
 - 40.- Own PLC applications in accordance with teacher and student requirements.

POSSIBILITIES OF OTHER AVAILABLE EXPANSIONS

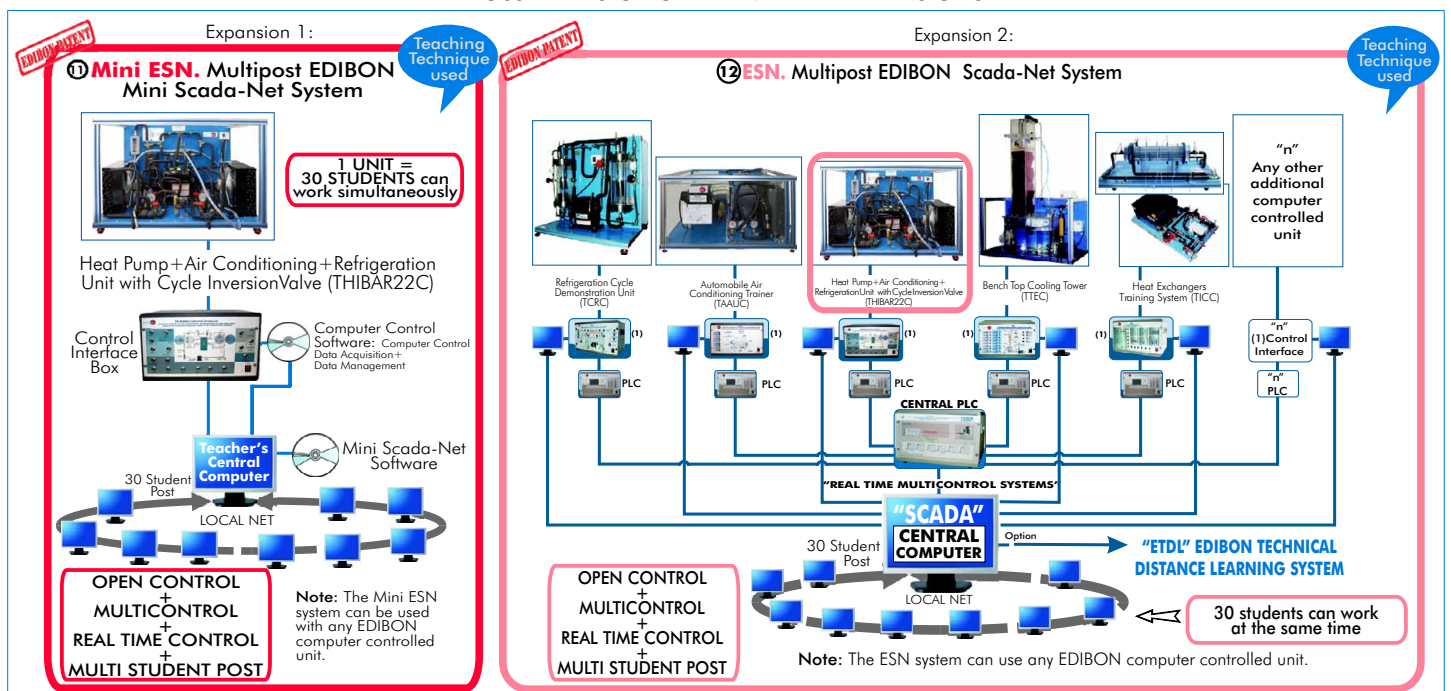

ORDER INFORMATION

Items supplied as standard

Minimum configuration for normal operation includes:

- ① Unit: THIBAR22C. Heat Pump+Air Conditioning +Refrigeration Unit with Cycle Inversion Valve (two condensers (water and air) and two evaporators (water and air)).
- ② THIBAR22C/CIB. Control Interface Box.
- ③ DAB. Data Acquisition Board.
- ④ THIBAR22C/CCSOF. Computer Control + Data Acquisition + Data Management Software.
- ⑤ Cables and Accessories, for a normal operation.
- ⑥ Manuals.

* **IMPORTANT: Under THIBAR22C we always supply all the elements for immediate running as 1, 2, 3, 4, 5 and 6.**

Complementary items to the standard supply

PLC. Industrial Control using PLC.(7 and 8):

- ⑦ PCL-PI.PLC Module.
- ⑧ THIBAR22C/PLC-SOF.PLC Control Software.
- ⑨ THIBAR22C/CAL. Computer Aided Learning Software (Results Calculation and Analysis). (Available on request).
- ⑩ THIBAR22C/FSS. Faults Simulation System. (Available on request).

Expansions

- ⑪ Mini ESN. Multipost EDIBON Mini Scada-Net System.
- ⑫ ESN. Multipost EDIBON Scada-Net System.

REQUIRED SERVICES

Electrical supply: 220V., 1-phase + neutral + ground, 50 Hz.; or 110V., 1-phase + neutral + ground, 60Hz.; and 1 CV max.

Water supply and drainage.

Computer (PC).

DIMENSIONS & WEIGHTS

| | |
|------------------------|--|
| THIBAR22C unit : | -Dimensions: 900 x 600 x 500 mm. approx. -Weight: 100 Kg. approx. |
| Control Interface Box: | -Dimensions: 490 x 330 x 310 mm. approx. -Weight: 10 Kg. approx. |
| PLC Module (PLC-PI): | -Dimensions: 490 x 330 x 310 mm. approx. -Weight: 30 Kg. approx. |

RECOMMENDED ACCESSORIES

For refilling R134a refrigerant and maintenance, we recommend:

- T/KIT1. Maintenance Kit, containing: vacuum pump, hoses and manometers.
- T/KIT2. Maintenance Kit, containing: leakage detector.
- R134a refrigerant (to be acquired by the customer locally).

AVAILABLE VERSIONS

Offered in this catalogue:

- **THIBAR22C.** Computer Controlled **Heat Pump + Air Conditioning + Refrigeration Unit with Cycle Inversion Valve (two condensers (water and air)and two evaporators (water and air))**.

Offered in other catalogue:

- **THIBAR22B.** **Heat Pump + Air Conditioning + Refrigeration Unit with Cycle Inversion Valve (two condensers (water and air) and two evaporators (water and air))**.

Other available versions:

- **THIBAR44C.** Computer Controlled **Heat Pump + Air Conditioning + Refrigeration Unit with Cycle Inversion Valve (four condensers(two of water and two of air) and four evaporators (two of water and two of air))**.
- **THIBAR44B.** **Heat Pump + Air Conditioning + Refrigeration Unit with Cycle Inversion Valve (four condensers (two of water and two of air) and four evaporators (two of water and two of air))**.

* Specifications subject to change without previous notice, due to the convenience of improvements of the product.



C/ Del Agua, 14. Polígono Industrial San José de Valderas.
28918 LEGANÉS (Madrid). SPAIN.
Phone: 34-91-6199363 FAX: 34-91-6198647
E-mail: edibon@edibon.com WEB site: www.edibon.com

Issue: ED01/10
Date: October/2010

REPRESENTATIVE: